

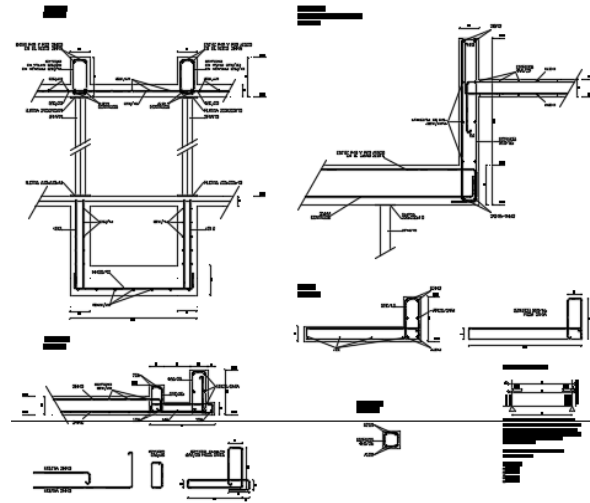

<https://tarjeta-lujanestructuras.carrd.co/>



**CURRÍCULUM GRÁFICO**  
Arq. Mauricio Chorbajian  
Abril 2024



**UDELAR**  
**CENTRO UNIVERSITARIO REGIONAL ESTE | ROCHA.**  
 Director: Arq. Pablo Briozzo.  
 Proyecto: Arq. Álvaro Cayón.  
 Asesor: Ing. Gonzalo Serantes.  
 Colaborador. Proyecto de estructura, coordinación.  
 Año 2010.

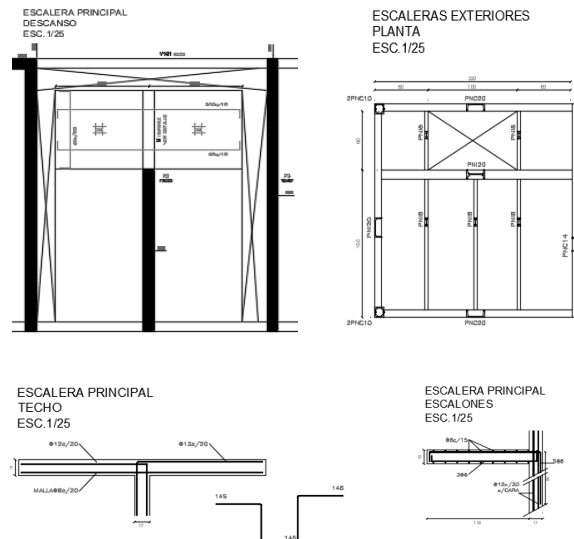

**UDELAR**  
**FVET | INSTITUTO DE PRODUCCIÓN ANIMAL**  
 Director: Arq. Pablo Briozzo.  
 Proyecto: Arq. Alejandro Baptista; Arq. Daniel Calzada.  
 Asesor: Ing. Gonzalo Serantes.  
 Colaborador. Proyecto de estructura, coordinación.  
 Años 2010-2011.

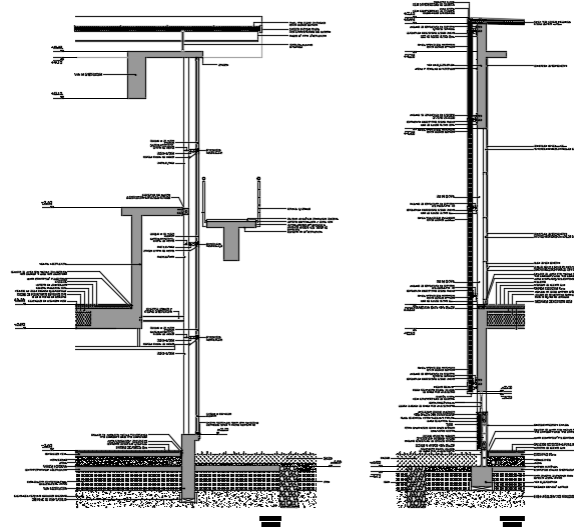

**UDELAR**  
**FACULTAD DE ENFERMERÍA | ESCUELAS DE LA SALUD**  
Director: Arq. Pablo Briozzo.  
Proyecto: Arq. Eduardo Laurito.  
Colaborador.  
Proyecto Ejecutivo y coordinación.  
Año 2011.



**UDELAR**

**FHCE | CENTRO DE POSGRADOS.**

Educación. Investigación. Aulas posgrados,  
Gabinetes docentes

Director: Arq. Juan Pedro Urruzola.

Proyecto y Dirección: Arq. Mauricio Chorbadjian.  
Año 2017.



**UDELAR**

**FHCE | SALONES MAGGIOLO Y CASSINONI.**

Educación. Aulas Magnas.

Director: Arq. Juan Pedro Urruzola.

Proyecto y Dirección: Arq. Mauricio Chorbadjian.  
Año 2019.





**UDELAR**  
**FHCE- INSTITUTO DE CIENCIAS ANTROPOLÓGICAS.**  
Investigación. Laboratorios. Gabinetes docentes.  
Director: Arq. Juan Pedro Urruzola.  
Proyecto y Dirección: Arq. Mauricio Chorbadjian.  
Año 2019..



**UDELAR**  
**FHCE - AULARIO EDIFICIO CENTRAL.**  
Enseñanza. Aulas comunes.  
Director: Arq. Álvaro Cayón.  
Proyecto y Dirección: Arq. Mauricio Chorbadjian.  
Año 2019.



**UDELAR**  
**FHCE | HALL Y CIRCULACIONES. EDIFICIO CENTRAL.**  
Espacios estructurales. Hall central. Sistema de circulaciones y acceso a aulas.  
Director: Álvaro Cayón.  
Proyecto y Dirección: Arq. Mauricio Chorbadjian.  
Año 2021..



**UDELAR**  
**FHCE – CIRCULACIONES. SERVICIOS.**  
Sala Lactancia. SSHH. Fotocopiadora.  
Director: Arq. Horacio Flora.  
Proyecto y Dirección: Arq. Mauricio Chorbadjian.  
Año 2022. En obra.





**UDELAR**  
**FHCE | BIBLIOTECA. EDIFICIO CENTRAL.**  
Refuncionalización. Nueva sala de lectura. Oficinas.  
Director: Horacio Flora.  
Proyecto y Dirección: Arq. Mauricio Chorbadjian.  
Año 2023.



**UDELAR**  
**FACULTAD DE DERECHO | CENTRO DE POSGRADOS**  
Educación. Aulas posgrados, Gabinetes docentes  
Director: Arq. Álvaro Cayón..  
Proyecto y Dirección: Arq. Mauricio Chorbadjian.  
Año 2022.

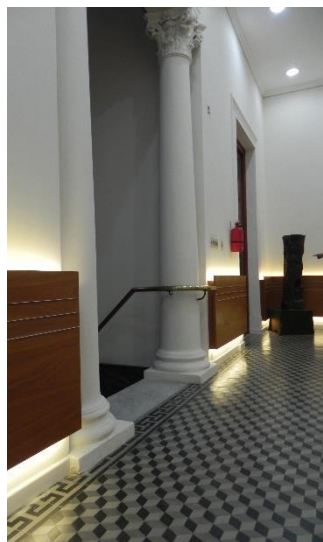

**UDELAR**  
**CURLN – PAYSANDÚ | SALA ATENEO.**  
Restauración edificio patrimonial.  
Director: Arq. Pablo Briozzo.  
Proyecto y Dirección: Arq. Mauricio Chorbadjian.  
Año 2017.

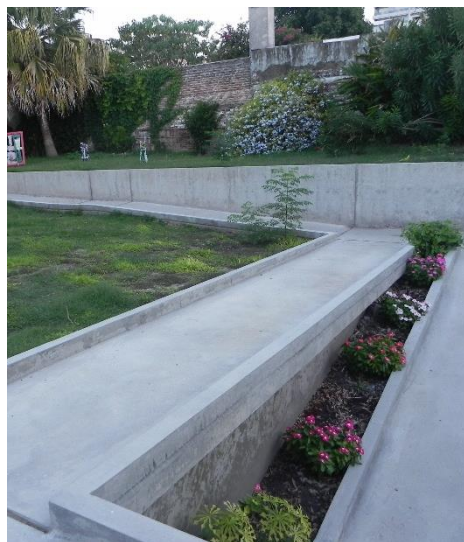

**UDELAR**  
**CURLN – PAYSANDÚ | PATIO CENTRAL.**  
Generación de espacios para la vida universitaria.  
Director: Arq. Pablo Briozzo.  
Proyecto y Dirección: Arq. Mauricio Chorbadjian.  
Año 2017.





**UDELAR**  
**FACULTAD AGRONOMÍA– PAYSANDÚ**  
**EEMAC | RESTAURACIÓN AULARIO MADERA.**  
Intervención en patrimonio edilicio.  
Director: Arq. Pablo Briozzo.  
Proyecto y Dirección: Arq. Mauricio Chorbadjian.  
Año 2017.



**UDELAR**  
**CURLN – SALTO | LABORATORIO SOLAR.**  
Edificio de Investigación en planta nueva.  
Director: Arq. Pablo Briozzo.  
Proyecto: Arq. Walter Castelli.  
Dirección: Arq. Mauricio Chorbadjian.  
Año 2013.



**UDELAR**  
**CURLN - FACULTAD AGRONOMÍA- SAN ANTONIO**  
**EEFAS | LABORATORIO DE ANATOMÍA.**  
Edificio de Investigación en planta nueva.  
Director: Arq. Pablo Briozzo.  
Proyecto: Arq. Walter Castelli.  
Dirección: Arq. Mauricio Chorbadjian.  
Año 2013.





**COVISAPU**  
Proyecto y Dirección de Obra.  
Conjunto de bloques 36 viviendas. San José.  
Año 2011.



**COVIFUSDU**  
Proyecto y Dirección de Obra.  
Conjunto de bloques 44 viviendas. Durazno.  
Año 2012.





**COPISUR**  
Proyecto y Dirección de Obra.  
Conjunto 30 viviendas. San José.  
Año 2014.



**COVIPENCO**  
Proyecto y Dirección de Obra.  
Conjunto 10 viviendas en altura. Montevideo.  
Año 2018.

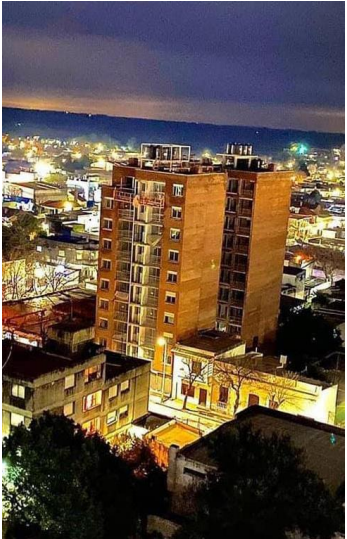

**COVILIFE**  
Proyecto y Dirección de Obra.  
Conjunto 35 viviendas en altura. Florida.  
Año 2020.

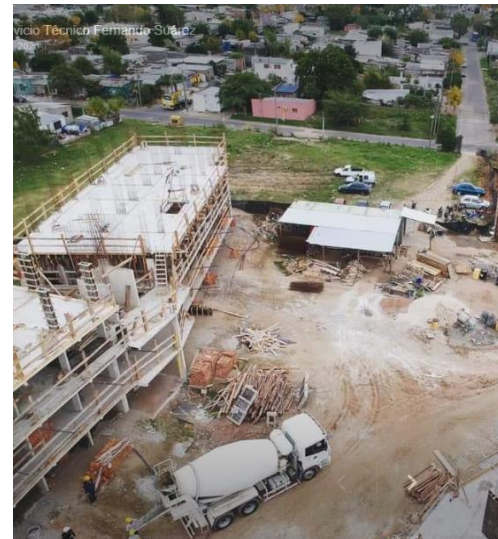

**FUPHO**  
Proyecto y Dirección de Obra.  
Conjunto 35 viviendas en altura. San José.  
Año 2020.





**UFAMA CORDÓN 1**  
Proyecto y Dirección de Obra.  
Conjunto 40 viviendas en altura. Montevideo.  
Año 2021.



**COVIRREYES**  
Proyecto y Dirección de Obra.  
Conjunto 35 viviendas en altura. San José.  
Año 2022.





**URUDATA**

Proyecto de fachada y diseño interior.  
Montevideo.  
Año 2005.



**VIVIENDA VALLARINO**

Proyecto. Barbacoa – Piscina – Gimnasio Privado.  
Montevideo.  
Año 2006.



**BLANCO - SICARDI ABOGADOS.**  
Intervención en monoambiente.  
Diseño de equipamiento estructurador.  
Montevideo.  
Año 2007..

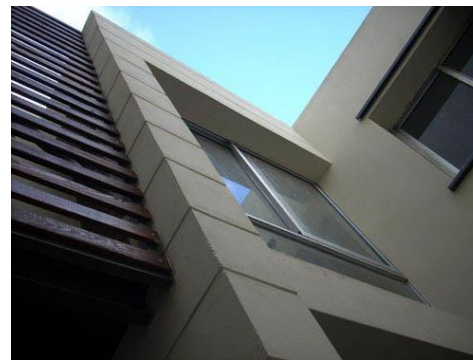

**RECICLAJE MERCEDES.**  
Reciclaje de vivienda  
3 dúplex más nivel azoteas con parrilleros.  
Montevideo.  
Año 2008.





**VIVIENDA GRAMPIN-BORBA**  
Reforma y ampliación de vivienda unifamiliar  
Montevideo-  
Año 2009.



**VIVIENDA MALDONADO**  
Reforma y ampliación de vivienda unifamiliar.  
Montevideo.  
Año 2009.





**VIVIENDA LAS FLORES**  
Obra nueva vivienda unifamiliar.  
Balneario Las Flores.  
Año 2010.



**VIVIENDA PALMAR**  
Reforma y ampliación de vivienda unifamiliar.  
Montevideo.  
Año 2012.



**VIVIENDA GRENNI-CASTRO**  
Obra nueva. Vivienda unifamiliar.  
Canelones.  
2014.



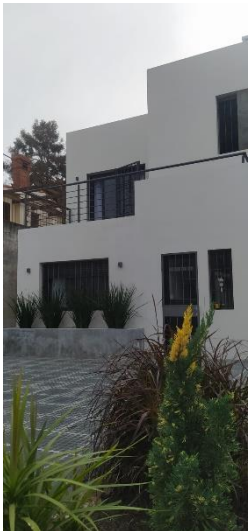

**VIVIENDA CARLOMAGNO**  
Reforma. Vivienda unifamiliar.  
Montevideo.  
2023.

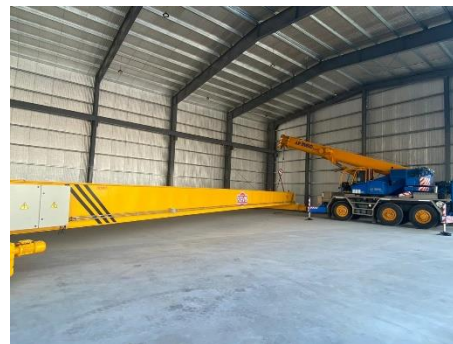
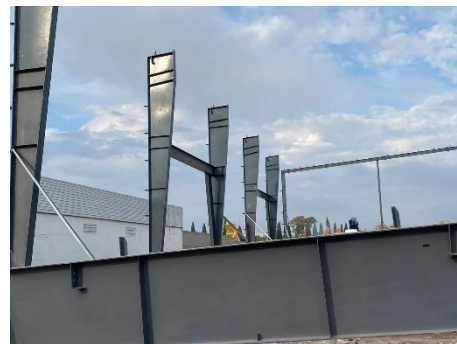

**LUJÁN ESTRUCTURAS**  
Representante en Uruguay  
<https://tarjeta-lujanestructuras.carrd.co/>  
mauriciochorbadjian@gmail.com  
Montevideo | Uruguay  
(+598) 99 321 075